

**Standardizing Fire Department Connections for Future Fire Protection Systems for
the Fairlawn Fire Department**

By: David Lesher
Lieutenant
Fairlawn Fire Department
3525 S. Smith Road
Fairlawn, Ohio 44333

A research project submitted to the Ohio Fire Executive Program

31 January 2019

CERTIFICATION STATEMENT

I hereby certify that the following statements are true:

1. This paper constitutes my own product, that where the language of others is set forth, quotation marks so indicate, and that appropriate credit is given where I have used the language, ideas, expressions, or writings of another.

2. I have affirmed the use of proper spelling and grammar in this document by using the spell and grammar check functions of a word processing software program and correcting the errors as suggested by the program.

Signed: David Lesher

Printed Name: DAVID LESHER

ABSTRACT

The lack of standardization of fire department connections (FDCs) within the City of Fairlawn Fire Department (FFD) could lead to fire suppression shortfalls. The purpose of this action research project was to determine if it would be feasible, as well as beneficial, to implement a standard for FDCs for the FFD. The following research questions were developed and evaluated: What is code and what standard should be followed? How have other departments standardized their fire department connections and what standard guidelines have they adopted? What type of fire department connection is best suited for the Fairlawn Fire Department suppression operation? What are the advantages and disadvantages of each connection? What kind of operational impact for the department would this standardization create? The research began with a literature review of numerous texts and articles relating to FDCs, which proved to be revealing. Additionally, the author conducted several interviews with local departments that contribute to fireground operations under Fairlawn's mutual aid box alarm system (MABAS), city engineer, and a local fire protection designer to assist with this action research. After gathering this information, the author developed two surveys: one that was distributed externally to fire departments throughout Summit County, Ohio; and one that was distributed internally to all full-time members of the FFD. The data was collected and used to evaluate the research questions. It was found that a standard for FDCs would be beneficial for the department. The recommendation from the author is to implement a Storz connection for all new fire protection systems for new commercial buildings. However, a Siamese connection should be considered for all buildings with standpipes and high-rise buildings defined by NFPA. This standardization for FDCs would address the fore mentioned problems facing the Fairlawn Fire Department.

TABLE OF CONTENTS

CERTIFICATION STATEMENT.....	2
ABSTRACT.....	2
TABLE OF CONTENTS.....	3
INTRODUCTION	4
Statement of the Problem.....	4
Purpose of the Study	5
Research Questions.....	5
BACKGROUND AND SIGNIFICANCE.....	5
LITERATURE REVIEW	10
PROCEDURES.....	17
Definition of Terms.....	21
Limitations of the Study.....	22
RESULTS	23
DISCUSSION.....	27
RECOMMENDATIONS.....	31
REFERENCES	35
APPENDIX 1 – NFPA, FDC Storz required dimensions.....	38
APPENDIX 2 – 6.2.2(a) End view of 4-inch metal face storz connection.....	39
APPENDIX 3 – 6.2.2 (b) End view of 5-inch metal face storz connection	40
APPENDIX 4 – Internal Survey.....	41
APPENDIX 5 – External Survey.....	42
APPENDIX 6 – FDC - Engineer Print	43

INTRODUCTION

Statement of the Problem

The problem that this research addresses is that Fairlawn Fire Department has not identified a standardization for fire department connections (FDCs) throughout the city, which could lead to shortfalls in the department's fire suppression capabilities. Fairlawn currently has no policy that determines what type of FDC should be used for fire protection systems in the city. There are various configurations throughout the city, and mutual aid companies may or may not carry appropriate adapters for this type of operation. Fairlawn is growing annually with new commercial industry facilities that require FDCs. Current standard operating guidelines (SOGs) are vague for this type of suppression operation and could lead to fire department suppression failures, extensive property damage and danger for firefighters if not addressed with a standardized FDC policy.

In 2014, a potential suppression pitfall was discovered while conducting a walk-through of an assembly that was under renovation, protected by a fire alarm and a limited-area sprinkler system. An FDC was discovered next to a hydrant on the property with a Siamese connection. Upon investigation, with the assistance of the Summit County Building Department and general contractor, we discovered the FDC does not support any part of any fire protection system within the building. Should an incident have occurred and the FDC had been placed in service for suppression operations, it could have been a catastrophic to the equipment, structure, and to the safety of firefighters.

It is unclear if the City of Fairlawn is following recommended practices to determine what standard for FDCs we should support and what type of FDC is best suited. Attempts have been made to investigate this problem, but very limited research has been conducted to

determine why there are so many different configurations of FDCs within the city and why an FDC standard has not yet been adopted.

Purpose of the Study

The purpose of this study is to define a standard for fire department connections for future commercial buildings within the City of Fairlawn. Upon completion, the findings and recommendations will be presented to the Fire Administration for approval.

Research Questions

During the course of this action research, the following questions will be addressed:

1. What is code and what standard should be followed?
2. How have other departments standardized their fire department connections and what standard guidelines have they adopted?
3. What type of fire department connection is best suited for the Fairlawn Fire Department suppression operation, and what are the advantages and disadvantages of each connection?
4. What kind of operational impact for the department would this standardization create?

BACKGROUND AND SIGNIFICANCE

The City of Fairlawn is located in Summit County, Ohio and is a suburb of the City of Akron. Established in July of 1971, Fairlawn covers 4.48 square miles with a population of 7,437 according to the 2010 census. Fairlawn has the third highest concentrations of services and retail companies in Summit County. Due to an influx of daily workers that commute to Fairlawn, this increases the population to over 40,000 individuals daily. The city is divided by Interstate 77, a heavily traveled corridor to the City of Akron and City of Cleveland. The most recent count of

active commercial businesses within the city is 847; this includes numerous shopping plazas and various three-story office buildings scattered throughout the city. High hazard occupancies include a 770,000-square foot retail mall, three hotels and three nursing homes. The city is home to several thriving companies whose corporate offices are in the city. These include:

A. Schulman, a leader in the polymer industry; Continental and Kumho Tire Corporation; and the Welty Company, a leader in construction management. The most common industries within the city include professional, educational, health care, and technical services (Advameg, Inc., 2000/2016).

The Fairlawn Fire Department (FFD) was established in 1981 to provide fire and emergency medical services to the citizens of the City of Fairlawn. The fire department, currently an ISO Class-2 community, provides an all hazard emergency service. Currently, the city is 98% protected with hydrants and the municipal water system is maintained by the City of Akron.

The department is a combination department with 16 full-time and 36 part-time personnel that operate out of one station. The fire station houses an engine, a ladder truck, three advanced life support ambulances and four support vehicles. FFD primarily has three shifts that full-time personnel work 24/48. Shifts are supplemented with part-time personnel to try and maintain five personnel at all times. The fire department is staffed with a minimum of four firefighters 24-hours a day and staffing increases during business hours of (07:00 AM – 4:00 PM), Monday through Friday. The increase in staffing during business hours include the Fire Chief, two administrative Captains, the fire prevention Lieutenant and a training Lieutenant.

The FFD has in place automatic aid agreements with neighboring communities and all communities depend on this to mitigate incidents. Fairlawn is described as a limited resource

department and generally has the capabilities to respond to initial calls. Additional calls require paging in off-duty personnel or contacting neighboring departments for mutual aid.

The Fairlawn Fire Department has provided fire prevention services since the inception of the department. It initially started out conducting fire safety inspections while on shift; it was not until 1994 that the department created a full-time fire prevention bureau. Job duties of the fire prevention bureau includes conducting fire safety inspections, providing public education, plan reviews and assisting with emergency calls as needed.

The City of Fairlawn has no building department. The Summit County Building Department is the authority having jurisdiction (A.H.J.) on new commercial construction until a certificate of occupancy is issued. However, the Ohio Fire Code provides the fire department the opportunity to review plans and submit comments on them during the plan review of fire protection systems. The Ohio Fire Code provides the authority to fire departments to evaluate plans for life safety issues and submit review comments to the local building department (Ohio Fire Code, 2011, p. 4). Currently, the City of Fairlawn enforces the Ohio Fire Code (O.F.C.), Ohio Building Code (O.B.C.) and supports the recommended practices of the National Fire Protection Association (N.F.P.A.).

The city is consistently growing with new commercial structures and build-outs. The city zoning department estimates 300 acres of vacant land are zoned for commercial use and anticipates a growing business industry in the next three to five years. In order for the city to stay competitive in this world of technology, city leaders have invested in a high-speed municipality broadband network called the Fairlawn-Gig. This technology provides additional services for the residents and our current corporate community, and entices other corporations to move into the city.

Since 2013, the fire prevention bureau has struggled to determine the appropriate type of FDC required regarding fire protection systems. Considering that an average of three new commercial properties a year require a fire protection system, the FFD must determine a standard. In the past, decisions on FDCs were based on the comparison of other buildings and which type of FDC was used. The fire department pre-plans provide little information about the FDC, besides location. There are no details about pumping pressures or if the FDC supports both a sprinkler and standpipe or just a sprinkler system. FFD has adopted the Akron thread pattern for all fire protection systems within the city, while others within our Mutual Aid Box Alarm System (MABAS) utilize National Standard Thread (NST) pattern.

As of November 2017, there were 94 FDCs throughout the city, with four different configurations. These configurations include 2 ½” Siamese connections, 2 ½” Siamese connection with a 4” Storz connection (combination), Siamese; one inlet a 2 ½” and one inlet a 4” Storz connection, finally either a single four or five-inch Storz connection (See Table 1).

Siamese (2-2.5)	Combination Siamese (2-2.5 & 1-4” Storz)	Siamese Connection (1-2.5 & 1-4” Storz)	Storz Connection 4” or 5”
61	13	14	6

Table 1; Types and Total of FDCs in Fairlawn

All but eight FDCs are yard FDCs within 40 feet of a hydrant, and 21 of the 94 FDCs within the city support a sprinkler and standpipe system. Finally, six FDCs are located on buildings on high-hazard properties. There are 24 buildings with Class I wet standpipe systems, four stories or less; 14 of these standpipes located on the property of a retail mall, and the other 10 scattered amongst the corporate community. The City of Fairlawn presently has no high-rise

buildings and has always tried to maintain this stature. City ordinances, however, do allow members of council, zoning, and director of public safety to approve these buildings.

The City of Fairlawn Ordinance 1602.03 (American Legal Publishing, 2018), passed in 2001, states that all FDCs shall be within 40 feet of a hydrant on the same side of the street, and the Director of Public Safety shall determine the type of FDC. Past documents do not make any suggestion as to why there are so many combinations of FDCs and why a particular FDC was selected. There is a chance this could cause operational confusion and lead to shortfalls in the department's fire suppression capabilities, but as the Authority Having Jurisdiction (A.H.J.), the FFD continues to sign off on the paperwork once a new fire protection system is in service.

The FDCs have been identified as a liability to fire department suppression operations, given the number of high-hazard commercial structures, the limited resources available, and dependency on a multi-jurisdictional response for all fires. There is a need to decrease the liabilities and the confusion of Fairlawn's FDCs for suppression operations. Personnel appear uncomfortable with the use of the FDC and discussions with local departments reveal no documentation about FDCs and what code or standard should be followed.

The potential impact this study could have on the Fairlawn Fire Department is ensuring there are no fire suppression shortfalls during an incident, eliminating operational confusion, along with remaining compliant regarding codes, standards and city ordinances.

The operational impact an FDC standard creates provides strategic direction and operational focus for the department achieved by three goals: 1.) Reducing Fire and Life Safety Risk Through Preparedness, Prevention and Mitigation; 2.) Promoting Response, Local Planning, and Preparedness for All Hazards; 3.) Enhancing the Fire and Emergency Services'

Capability for Response to and Recovery from All Hazards (U.S.Fire Administration, 2014-2018).

The first goal, Reducing Fire and Life Safety Risk Through Preparedness, Prevention and Mitigation, begins with adopting preparedness, prevention and mitigation strategies including code development and compliance.

The second goal, Promoting Response, Local Planning and Preparedness for All Hazards, provides programs and training to improve local planning, preparedness, and decision-making through the use of modern data and information analytics. This will improve fire and emergency services' ability to identify, prevent mitigate and respond to local community hazards (U.S.Fire Administration, 2014-2018).

The third goal, Enhancing the Fire and Emergency Services' Capability for Response to and Recovery from All Hazards, is to enhance fire and emergency services capabilities to respond to and recover from all hazardous incidents through training, education, exercise, and evaluation. Our goal is to promote a culture of health, wellness, and behavior that enhances emergency responder safety and survival. Finally, we encourage the adoption of technological tools to improve fire and emergency services' capability of, preparation for, response to, and recovery from all hazards (U.S.Fire Administration, 2014-2018).

LITERATURE REVIEW

While evaluating whether a standard for FDCs would be feasible and beneficial for the members of the FFD, the author reviewed several articles and text books from several fire-related publishers, conducted interviews, and evaluated all information. The author commenced this research understanding the crucial role the FDC has on water-based fire protection systems.

According to the Essentials of Fire Fighting and Fire Department Operations (IFSTA, 2013, pp. 1202-1203), if a fire occurs, the sprinkler system needs an outside source of water and pressure to do its job efficiently. A fire department pumper connected to the sprinkler fire department connection can provide additional water and pressure. The FDC for sprinklers consist of a Siamese inlet with a least two 2 ½-inch female connections with a clapper valve, or one large-diameter connection. Fire department connections not only supplement the sprinkler system, they also support the water source to a standpipe system. To date, sprinklers continue to be the most effective method of fire control, both in commercial and residential properties, provided they have the required water source to support the system. Industry standards such as NFPA 13: Standard for the Installation of Sprinkler Systems, and NFPA 14: Standard for the Installation of Standpipe and Hose Systems, require FDCs to be installed on nearly all sprinkler and automatic sprinkler systems.

An FDC is defined as “a connection through which the fire department can pump supplemental water into the sprinkler system, standpipe, or other water-based fire protection systems, furnishing water for fire extinguishment to supplement existing water supplies” (NFPA 24, 2016, p. 8).

The 2011 edition of The Ohio Fire Code documents that FDCs shall be installed in accordance with NFPA standards, applicable to the system design. Exceptions to this rule include (FDCs are not required for):

1. Limited-area sprinkler systems supplied from the domestic water system.
2. Automatic sprinkler systems having less than 20 sprinklers.

The threads for FDCs shall be compatible with the local fire department as defined in the Ohio Fire Code and hose threads used in conjunction with standpipe systems shall be approved and compatible with fire department hose threads (Ohio Fire Code, 2011, p. 195).

NFPA 13: System Components and Hardware (2016), states the FDC(s) shall consist of two 2 ½ inch connection using NH internal threaded swivel fittings(s) with “2.5-7.5 NH standard thread,” as specified in NFPA 1963. The use of non-threaded couplings shall be permitted where required by the AHJ and where listed for such. Also, NFPA 13 states the FDC shall be equipped with approved plugs or caps, adequately secured and arranged for easy removal by fire departments. Finally, the fire department connections shall be of an approved type.

The installation requirements for the piping to the FDC shall be a minimum of four inches for a fire engine connection but for hydraulically calculated systems, the pipe size shall be permitted to be less than four inches, but not less than the largest riser being served by that connection. The FDC and piping shall be listed for a working pressure equal to or greater than the pressure requirements of the system demand (NFPA 13, 2016, p. 100).

The FDC requirements in NFPA 14 are more explicit than the requirements in NFPA 13 and specifically call for FDCs to have one 2 ½-inch inlet per every 250 G.P.M and an approved large diameter hose connection size to accommodate the required flow shall be permitted (NFPA Research Foundation, 2016, p. 4). A typical standpipe system in a fully sprinkler protected facility may need up to four FDC inlets to satisfy the system demand. The “*system demand*” is defined as the flow rate and residual pressure required from a water supply, measured at the point of connection of a water supply to a standpipe system, to deliver the total water flow rate and the minimum residual pressure required for a standpipe system at the hydraulically most

remote hose connection, and the minimum water flow rate and residual pressure for sprinkler connections on combined systems (NFPA 14, 2016, p. 9).

NFPA documents that the location of the FDC shall be located so that hose lines can be attached to the inlets without interference. The FDC can be located not more than 100 feet from the nearest hydrant, and the FDC shall be permitted to exceed 100 feet, subject to the approval of the AHJ. This standard defines the height requirements of an FDC, which should be not less than 18 inches and not more than 48 inches above the level of the adjoining ground, sidewalk or grade surface. Signage shall be placed to designate the specific FDC services (e.g., “STANDPIPE AND AUTOSPKR” or “AUTOSPKR AND STANDPIPE”) (NFPA 14, 2016, p. 18).

The Fire Protection Handbook, 18th Edition, notes that most fire department connections are provided with one 2 ½-inch inlet for every 250 gallons per minute (G.P.M) of design flow rate. Shapiro (1997) outlines that the inlets can be designed to connect to a large diameter hose. However, a second inlet is needed to allow for a backup line that could be put into operation if the first hose ruptures or separates from a coupling.

The standard for Fire Hose Connections (NFPA 1963, 2014, p. 18) defines the design of a non-threaded or Storz connection, and that it shall be metal-faced, without gaskets. Non-threaded fire department connections shall be made to the dimensions specified in Figure 6.8.2 (Appendix 1). The four-inch metal-faced hydrant and fire department connections shall meet the dimensional characteristics of Figure 6.2.2(a) (Appendix 2), and five-inch metal-faced hydrant and fire department connections shall meet the dimensional characteristics of Figure 6.2.2 (b) (Appendix 3).

In November of 2016, a leader among third-party testing companies, Factory-Mutual (FM), conducted research on FDCS, Approval Standard for Fire Department Connections, Class

Number 1530 (FM Global Group, 2016). It focused on the design and performance requirements for FDCs if manufacturers of FDCs want to display the FM-approval certification mark on their products. The general requirements of the FDC will have a minimum rated working pressure of 175 psi (1205kPa), the minimum pressure rating considered for FM approval. This approval by FM states the FDC shall have a single four-inch (100mm) or two 2 ½-inch (63 mm) female hose inlets with swivels and a four-inch iron pipe size (IPS), minimum outlet. Each inlet shall be provided with a suitable washer and conform to NFPA, 1963. The hose inlets may attach to the body or may be part of an adapter; the swivels shall have spanner lugs. This third-party testing group reported the inlets need to be arranged so that the hose can be conveniently attached to or removed from one inlet while the other is in service with a single or dual clapper arrangement. A protective plug that can be readily removed or broken shall be provided on each inlet to protect the hose threads and prevent foreign material from entering the FDC.

FM Global Group (2016) continued testing the performance requirements of FDC and documented that the FDC shall be able to withstand a hydrostatic pressure of 700 psi or four times the rated working pressure (whichever is greater) for five minutes without sustaining cracking or permanent deformation. The clapper(s) shall prevent excessive leakage when subjected to water pressure at 125% of the rated working pressure for five minutes and water leakage shall not exceed one pint. This data provided by FM does not provide flow test data; however, it specifies that the minimum rated working pressure shall be 175 psig (FM Global Group, 2016, p. 10).

The author conducted research of other departments within FFD MABAS and contacted adjacent counties to determine if any departments have established a standard for FDCs. Departments within the MABAS that were contacted include the Bath Township Fire

Department, Copley Township Fire Department and The City of Green Fire Department. The Kent Fire Department, a department adjacent to Summit County, was also included in this research.

In January of 2016, the NFPA Research Foundation initiated a project to determine the actual flow achieved for each 2 ½-inch inlet on an FDC. The NFPA Research Foundation (2016) provided information on jurisdictional adoption for FDCs and to establish the most common arrangement for FDCs. The 2014 New York City Administrative Code requires at least one Siamese connection, an FDC with two-way inlets, for every 300 feet of exterior wall. The Municipal Code of Chicago requires at least one Siamese connection on each street exposure. However, if a building has a street exposure more than 250 feet long, two Siamese connections are required, spaced at least 200 feet apart.

Structural Firefighting Strategy and Tactics (third edition) reports the typical Siamese connection, two female 2 ½-inch intakes supported by two 2 ½, or three-inch hose lines, is currently being substituted with a large-diameter hose (four-inch or five-inch) with the use of a Storz connection for an FDC. Klaene (2016) lists some advantages and disadvantages of a Storz connection. The advantage is the availability of using a large-diameter hose to support the FDC with a large quantity of water, which leads to reduced friction loss. Only one section of large-diameter hose is required and can accommodate a quicker connection to an FDC. However, there are potential problems outlined by the standard to address when using large-diameter hose to supply a sprinkler or standpipe system:

- 1.) The weight of the hose and water bearing on the FDC is significant.
- 2.) Kinking is more likely with LDH, due to size.

- 3.) The Storz connection can accidentally disconnect if no locking mechanism is in place.
- 4.) There is no redundancy. (If a single section of large-diameter hose ruptures, the total supply to the FDC is lost).
- 5.) Standard large-diameter hose generally tested at a lower pressure than 2 ½-inch or three-inch hose.
- 6.) If a leak at the Storz connection is discovered, cannot be tightened with the use of a spanner wrench.

Large-diameter hose is typically tested to 200 psi and generally classified as a supply hose. This rating is adequate for most sprinkler operations, but higher pressures may be required for standpipe operations in high-rise buildings. Large-demand sprinkler systems or standpipes requiring flow of more than 750 GPM are still better served by multiple (three or more) hose lines through a 3-way or 4-way FDC (BSD SpecLink, 2014, p. 3).

The article, “Understanding the Use of Fire Department Connections” (Rowett, 2017) states that the Siamese connection is protected by a protective cap to keep debris out of the piping to the FDC and to prevent damage to the threads. A disadvantage of these caps is that they become damaged and come up missing, allowing the potential for debris to get into the piping of the FDC or even become encrusted in the piping due to lack of maintenance. The female swivel can become frozen on the Siamese connection of the fire department connection, requiring an additional double male adapter to be threaded onto the FDC before connecting the hose.

The main advantage of a Siamese connection is that it is universally used as a source of supply to the fire protection system, and separate connections are commonly provided for automatic sprinklers and standpipe systems. If one hose fails, the operation can keep supporting

these systems while the hose is changed, unlike the use of a Storz connection utilizing a large diameter hose.

Operationally, FFD should complete a needs assessment when operational requirements change. The needs assessment identifies areas where SOPs are deficient and summarizes specific requirements for changes to existing guidelines. This process should be performed to help keep SOGs current and valid. Existing SOGs should be modified or a new one should be developed to reflect the change in standards of practice for the local needs. When implemented, the FFD should inform everyone of the new or modified SOG and ensure understanding of the significance of the change. Copies should be distributed as needed and be made readily accessible to users. All personnel should know their roles and have the knowledge and skills necessary to implement the SOG safely and effectively.

Current pre-plans should be re-evaluated to identify buildings with sprinkler and standpipe systems. Failure to obtain this information could result in the failure of fire ground operations. Pre-plans should identify the type of FDC, location, and what areas of the building is serviced by the FDC (Rowett, 2017). Other information included on pre-plans include building construction, building access, hazards, utility locations and contact information for the building.

FFD should complete an evaluation of current equipment on the trucks to determine if the correct adapters and hoses are in service on the truck. This includes designating one or two sections of large-diameter hose for Storz connection and 2 ½ -3-inch hose for a Siamese connection for FDC operations. FFD should also complete a local assessment of area departments to determine if these departments have the necessary equipment for this type of operation.

After completing this literature review and seeing how much has been written in regard to FDCs, the author recognizes how important the FDC is to fire protection systems. The FFD needs to strongly consider and understand the fire protection systems being reviewed and the associated codes and recommended standards that are in place. An evaluation should be taken of what other departments have in place and what the advantages and disadvantages are for each type of FDC. With the proper guidance though, this standardization will build, sustain, and improve FFD's capability to prepare for, protect against, respond to and mitigate a hazard while supporting the strategic framework of the U.S. Fire Administration.

PROCEDURES

The purpose of this study is to identify a standard for FDCs to eliminate any operational confusion, prevent any fire suppression shortfalls and provide compliance to codes, standards and city ordinances of Fairlawn. The American Psychological Association Manual 6th edition was the required format for this paper. The literature review provided valuable background information and understanding for creating surveys/questionnaires directed at answering the following research questions: a.) What is code and what standard should be followed? b.) How have other departments standardized their fire department connections and what rule have they adopted? c.) What type of fire department connection is best suited for the City of Fairlawn Fire Department suppression operation, and what are the advantages and disadvantages of each connection? d.) What kind of operational impact for the department would this standardization create?

The author began the research internally to determine how many commercial buildings within Fairlawn's jurisdiction have FDCs that support a fire protection system. The author

created an Excel spreadsheet, which included the address, number of stories, type of FDC in service, and whether the FDC services a sprinkler system or a combination sprinkler/standpipe system. Current pre-plans were reviewed to verify the information and gain additional information on FDCs throughout the city. However, current pre-plans provided generic information that only included the location of the FDC. The author also researched and reviewed FFD archives and databases of past plan review comments to the local building and zoning department.

Internet searches were performed from the National Fire Academy Executive Fire Officer and the Ohio Fire Chiefs Fire Executive archives on research papers related to FDCs. This internet search provided very little information solely on FDCs. The author continued internet research efforts electronically, utilizing Google (<http://google.com>) and NFPA (<https://codesonline.nfpa.org>). The author also contacted a local sprinkler design company, S.A. Comunale, for additional research materials. Literature review continued within the author's office, The Fire Prevention Bureau of the FFD examining books that included IFSTA, state fire and building code books and city ordinances.

The author scheduled an interview with fire prevention members from Bath and Copley Township Fire Departments on December 7, 2017. Before meeting, he developed five questions to assist with the research:

- 1. Does your department have a standard or township ordinance on FDCs?*
- 2. What type of FDC is used on new commercial structures when required and why?*
- 3. Why are there are so many different types of FDCs throughout your jurisdiction?*
- 4. Is there an advantage to using a Storz connection vs. Siamese connection and are there any disadvantages to these connections?*

5. *As a primary mutual aid company, what type of FDC would your department like to see within the City of Fairlawn and why?*

The purpose of the interview was to research FDCs in other jurisdictions and investigate their process for determining the type of FDCs. Observation before the meeting showed commercial structures within their municipalities with similar problems as FFD.

The author pursued further research by distributing two separate online surveys through Survey Monkey (www.surveymonkey.com) to obtain data feedback internally and externally. The internal survey was emailed to 14 full-time members and 12 surveys were completed. The email contained a cover letter and a direct web link to the survey (Appendix 4). The survey asked the following seven questions:

- 1.) *How useful is the FDC for suppression operations in commercial structures?*
- 2.) *Would a standardization for FDCs be beneficial for Fairlawn Fire Department?*
- 3.) *If a standard for FDCs was implemented, what type should be utilized?*
- 4.) *If a Storz connection was implemented what size should be used?*
- 5.) *Should 3-inch or 2.5-inch hose be used on a Siamese connection due to friction loss?*
- 6.) *How familiar are you with operation of an FDC if needed for suppression operations?*
- 7.) *Do you feel the department has provided you with enough training and information on FDCs for adequate suppression operations?*

Twenty-seven fire departments within Summit County, Ohio received an external survey coordinated by the Secretary for the Summit County Fire Chiefs Association. Fifteen other fire departments outside of Summit County, Ohio also received the survey. The survey contained a

cover letter and a direct web link to the survey on Survey Monkey (Appendix 5). Thirty responses were recorded for this survey. The survey asked the following nine questions:

- 1.) *Does your department reference NFPA standard on their local Fire Protection Systems and FDCs?*
- 2.) *Does your department have a standardization for FDCs within your jurisdiction?*
- 3.) *Who determines within your jurisdiction what type of FDC will be utilized for fire protection?*
- 4.) *What type of FDC is required in your jurisdiction on new commercial buildings when required?*
- 5.) *What operational advantages/disadvantages were identified in the department's FDC selection in question two? Please explain.*
- 6.) *If your jurisdiction utilizes a Storz connection for an FDC, what size is this connection?*
- 7.) *When selecting an FDC, how important is it to have the markings of a third-party testing facility, e.g., Factory Mutual (FM), Underwriters Laboratory (UL)?*
- 8.) *Approximately how many times in the past 10 years was an FDC placed in service for suppression operations within your community?*
- 9.) *Does your city/village/township have buildings where the floor of an occupiable story is greater than 75 ft. (high-rise)?*

Definition of Terms

AHJ: Authority Having Jurisdiction - an organization, office, or individual responsible for enforcing the requirements of a code or standard, or for approving equipment, materials, an installation, or a procedure (NFPA 1 Fire Code, 2018).

FDC: Fire Department Connection - a connection through which the fire department can pump supplemental water into the sprinkler system, standpipe, or other system furnishing water for fire extinguishment to supplement existing water supplies (NFPA 1963, 2014).

FFD: Fairlawn Fire Department.

High Rise: A building where the floor of an occupiable story is greater than 75 ft (23 m) above the lowest level of fire department vehicle access (NFPA 14, 2016).

IFSTA, International Fire Service Training Association: An association of fire service personnel which identifies areas of need for training materials and fosters the development and validation of training materials for the fire service (IFSTA, 2013).

NFPA: National Fire Protection Association is a global nonprofit organization, established in 1896, devoted to eliminating death, injury, property and economic loss due to fire electrical and related hazards (NFPA, 2018).

NFPA 13: Standard for the Installation of Sprinkler Systems (NFPA 13, 2016).

NFPA 14: Standard for the Installation of Standpipe and Hose Systems (NFPA 13, 2016).

NFPA 1963: Standard for Fire Hose Connections (NFPA 1963, 2014).

NFPA Research Foundation: An affiliate of NFPA is an independent nonprofit whose mission is to plan, manage and communicate research in support of the association (NFPA Research Foundation, 2016).

Non-Threaded Connection: A coupling or adapter in which the mating is achieved with locks or cams but without the use of screw threads (NFPA 1963, 2014).

O.F.C: Ohio Fire Code - The purpose of this code is to establish the minimum requirements consistent with nationally recognized good practice for providing a reasonable level of life, safety and property protection from the hazards of fire, explosion or dangerous conditions in new and existing buildings, structures and premises and to provide safety to fire fighters and emergency responders during emergency operations (Ohio Fire Code, 2011).

Siamese Connection: Hose appliance used to combine two or more hose lines into one. An example of a Siamese connection is a fire department connection (IFSTA, 2013, p. 835).

Storz Connection (Non-Threaded Connection): Non-threaded (sexless) coupling commonly found on large-diameter hose. Non-threaded fire hose couplings have been used in North American fire and emergency services since the early 1900s. With this type

of coupling, the mating of two couplings is achieved with locks or cams without the use of screw threads (IFSTA, 2013, p. 823).

Limitations of the Study

Once all the recorded results were reviewed, the author recognized that Question 5 of the external survey was out of order and should have been asked after Question 2. There were four skipped responses asking to list the advantages /disadvantages in the departments' FDC selection for their jurisdiction in question two. The author believes these omitted responses were due to the respondents needing to refer back to Question 2 to reread the question. Question 5 of the internal survey appears to have no relevance to this research. This research is driven towards creating a standardization for FDCs for current and future commercial buildings within the City of Fairlawn.

One other limitation reported was the lack of documented information that was reported on Storz connection for FDCs. Even though codes and recommended standard report that a Storz connection can be used for FDCs, search engines and articles were limited.

RESULTS

The action research process helped the author to conclude that the Fairlawn Fire Department can benefit from having an FDC standardization, and was applied to answer the following research questions:

1. What is code and what standard should we be following?
2. How have other departments standardized their fire department connections and what rules have they adopted?

3. What type of fire department connection is best suited for the Fairlawn Fire Department suppression operations and what are the advantages and disadvantages of each connection?
4. What kind of operational impact for the department would this standardization create?

The author created two different surveys with the research questions in mind. The first survey was sent internally to 14 members of FFD with a 91% response rate (Appendix 4). The second external survey was distributed to 27 fire departments throughout Summit County, Ohio with a 70% response rate (Appendix 5).

The results from the external survey revealed that most departments reference NFPA or adopt NFPA as a rule when dealing with fire protection systems and FDCs. Question 1 of the external survey asked, “Does your department reference NFPA standard on their local Fire Protection Systems and FDCs?” The results indicated that 87% of the respondents reference NFPA and 13% of the respondents answered that they do not reference NFPA. Respondents did not provide a reason to explain why they do not reference NFPA or what code/standard they referenced. The external survey Question 7 asked, “When selecting an FDC, how important is it have the markings of a third-party testing facility, e.g., Factory Mutual (F.M.), Underwriters Laboratory (U.L.)?” The results indicated that 73% reported “extremely important to somewhat important,” while the remaining 27% reported, “not so important to not at all important.” Question 1 of the internal survey asked, “How useful is the FDC for suppression operations in commercial structures?” The results indicated that the FDC is “extremely useful or very useful.” The author utilized Question 1 of the internal survey to determine how important a standardization for FDCs is to the FFD.

The external survey revealed that most departments have some type of standard for FDCs. Question 2 asked, “Does your department have a standardization for FDCs within your jurisdiction?” The results indicated that 83% do have a standardization for FDCs and 17% do not. Question 3 of the external survey asked, “Who determines within your jurisdiction what type of FDC will be utilized for fire protection systems?” The results indicated that 87% of the fire departments determine the type of FDC, 10% reported the local building department makes that determination, and 3% responded that local ordinances determine the type of FDC. Question 2 of the internal survey asked, “Would a standardization for FDCs be beneficial for Fairlawn Fire Department?” All respondents to this question agree that having an FDC standard would be beneficial to FFD.

To determine the type of FDC best suited for FFD suppression operations, Question 3 of the internal survey asked, “If a standard for FDCs was implemented, what type should be utilized?” The results indicated that 67% favor a Storz connection and 33% prefer a combination, Storz & Siamese connection. Question 4 of the internal survey asked, “If a Storz connection was implemented, what size should be used?” Reported responses indicated 92% for a five-inch Storz and 8% for a four-inch Storz. Question 4 in the external survey asked, “What type of FDC is required in your jurisdiction on new commercial buildings when required?” Results reported 53% require a Storz connection, 23% a Siamese connection and 23% a combined Storz & Siamese connection. Question 6 of the external survey asked, “If your jurisdiction utilizes a Storz connection for an FDC, what size is this connection?” Responses demonstrated 60% use a five-inch Storz, 17% for a four-inch Storz, and 23% reported “not applicable.”

The external survey noted 26 responses that listed advantages and disadvantages of each type of connection and four respondents that skipped the question. Question 5 of the external

survey asked, “What operational advantages/disadvantages were identified in the department’s FDC selection? Please explain.” Responses reported numerous advantages of a Storz connection which include simplicity/speed, standardization with other companies, easily adapted to current hose, and quicker use with limited workforce. One disadvantage reported for a Storz connection (using single LDH hose equipped with a Storz connection) is that it limits operational flexibility. This response, however, was driven toward the use of an FDC with a Storz connection on high-rise operations.

Results of Question 5 of the external survey identified one advantage of a Siamese connection as having continuity with a Siamese connection and one disadvantage that it needs continuous maintenance due to caps freezing and the use of adapters.

Finally, Question 5 of the external survey reported two similar answers as an advantage of a combination type FDC with a Storz and Siamese connection. This response was noted if Storz connection fails, the Siamese can be used as a backup. Results reported no disadvantage of a combination FDC.

The city of Fairlawn does not currently have any high-rises. In planning for the future to determine the proper FDC for FFD suppression operations for these buildings, Question 9 of the external survey asked, “Does your city/village/township have buildings where the floor of an occupiable story is greater than 75ft (High-Rise)?” The survey indicated that 75% do not, and 25% of those with high-rises all reported a Siamese connection.

The operational impact an FDC standardization would have on the department, according to the survey, would be minimal. All personnel internally recognize the importance of the FDC, according to internal survey questions. Question 6 of the internal survey asked, “How familiar are you with the operation of an FDC if needed for suppression operations?” The results

indicated 83% are “extremely familiar to very familiar” with the operation of an FDC. However, additional training needs to be considered. Question 7 asked, “Do you feel the department has provided you with enough training and information on FDCs for adequate suppression operations?” The results indicated 58% report enough training provided and 42% feel there has not been enough training. To determine how soon this standardization could impact the department operationally, Question 8 of the external survey asked, “Approximately, how many times in the past 10 years was an FDC placed in service for suppression operations within your community?” Results reported that an FDC was placed in service less than ten times or 67% over the past 10 years, 17% indicated putting an FDC in service more than ten times, and 17% reported they have never placed an FDC in service over the past 10 years.

The results of the general interview that the author conducted December 7, 2017, concluded that neither the CFD or BFD have township ordinances or a policy in place for FDCs. No reason was given as to why there is a mix of Storz and Siamese connections throughout their jurisdictions. Both departments report that any new commercial building requiring an NFPA 13 or NFPA 14 fire protection system, that the FDC will be a five-inch Storz connection. The interview documented some advantages, including ease of use, ease of maintenance, and universality. Also, a five-inch Storz connection with a large diameter hose will meet the system demand requirements for the sprinkler and standpipe systems. The interview revealed one disadvantage of a Storz connection: that there is a need to determine a height requirement for an FDC. The final question, “As a primary mutual aid company, what type of FDC would your department like to see within the City of Fairlawn?” Both members interviewed believe that a five-inch Storz connection would be beneficial for City of Fairlawn to provide consistency throughout all response areas. The City of Green Fire Department and the Kent Fire Department

reported all new commercial buildings with a fire protection system utilize a Storz connection. Both departments responded that an engineer print is submitted to the building department and the contractor. The guidelines used by these departments to develop an engineer print include O.F.C, O.B.C, NFPA 13 and NFPA 14. One important aspect the author noticed while reviewing the engineer prints that were submitted for review was a 30-degree downturn was implemented on FDCs with a Storz connection.

DISCUSSION

The Fairlawn Fire Department needs to make some improvements, determining what type of FDC should be installed on new fire protection systems. Making this determination has been inconsistent and has not been a priority over time, as archives show. From 2013 to 2017, records indicate that a Storz connection was fitted to all new fire protection systems within the city. There is still an inconsistency on size and if a second inlet is required as a backup, as documented in the Fire Protection Handbook (Shapiro, 1997, pp. 6-258). To date, the Fairlawn Fire Department and the author believe the FDC is useful for suppression operations in commercial structures, and standardization would be beneficial to the department as well as to those it serves.

The literature review and surveys show most fire departments reference NFPA when inquiring about fire protection systems and FDCs. The Industry standard NFPA 13 and NFPA 14, require FDCs installed on most sprinkler and automatic sprinkler systems. Most fire departments believe that having the markings of a third party, e.g., FM on the FDC, is essential. The markings from these companies verify that these products conform to the highest standard for safety and performance under NFPA (FM Global Group, 2016) .

In Chapter 6 of NFPA 13, Fire Department Connections state that the FDC shall consist of two 2 ½-inch connections using NH internal threaded swivel fitting(s) with “2.5-7.5 NH standard thread and the use of non-threaded connection shall be permitted where required by the authority having jurisdiction where listed for such use” (2016). The O.F.C. reports that all FDCs be installed in accordance to the applicable NFPA standard. The O.F.C. (Ohio Fire Code, 2011) however, does document that the FDCs threads shall be compatible with local fire departments.

Most fire departments evaluated outside of our MABAS do have some minimum form of an FDC standard that includes an engineer print used during the plan review process. These engineer prints define the type of FDC, height, and location of the FDC as referenced from the City of Green Fire Department, in Summit County, Ohio. The City of Kent Fire Department, located in Portage County, Ohio, utilizes a Storz connection that is documented in their plan review letter, which is forwarded to the contractor. When asked what the reason for the 30-degree downturn on a Storz connection was, both departments reported it helps support a large diameter hose and minimize kinking.

In Chapter 6 of NFPA 14, in the Location and Identification (2016) section, it states that the FDC shall be located within 100 feet of a hydrant and the height shall be located not less than 18 inches and not more than 48 inches above the level of the ground, sidewalk or grade surface. The external survey revealed that more than 80% of the fire departments determine the type of FDC for their suppression operations. The author researched departments within their primary MABAS, and no department has a standardization of this nature, which includes an engineer print. However, the type of FDC is generally commented on a memo to the local building department and contractor.

The survey demonstrated that a Storz connection was primarily used for an FDC, then surprisingly a combination setup second, and the Siamese connection third. Most jurisdictions within Summit County, Ohio use either a five-inch or four-inch Storz connection for an FDC. FFD would like to see a five-inch Storz connection, followed by a combination setup on any new commercial buildings for suppression operations. For FFD operations, this type of connection is better suited for operations over a Siamese connection due to ease of use, limited workforce, lack of high-rises, and ease of maintenance.

The main advantage of using a Storz connection is having the availability of using a large-diameter hose to support the sprinkler/standpipe system with a large of quantity of water and less friction loss. Another advantage is that only one section of large-diameter hose is usually required, and the connection to the FDC is streamlined. However, the City Ordinance of Fairlawn does stipulate that an FDC needs to be within forty feet of a hydrant (American Legal Publishing, 2018). Conversely, there are some disadvantages to using a Storz connection with large-diameter hose. For instance, the weight of the hose and water bearing on the FDC are significant, kinking of the large-diameter is more likely, the Storz connection can be accidentally disconnected if no locking mechanism is in place, there is no back-up, the large-diameter hose is tested at lower pressure than a 2 ½-inch or three-inch hose, and if a leak is discovered at the Storz connection, it cannot be tightened.

Large-diameter hose is typically tested to 200 psi, and this rating is adequate for most sprinkler operations, but high-rise operations with occupied stories greater than 75 feet, may require higher pressures for standpipe operations (Klaene, 2016, p. 250). One important element that FFD has not considered is the hydraulic calculation of a sprinkler or standpipe system. BSD SpecLink (2014) reported that a large-demand sprinkler or standpipe system requiring a flow of

more than 750 gpm are better served with a three-way or four-way FDC instead of a Storz connection.

The advantage of a Siamese connection with two female, 2 ½-inch connections, is its protection by a cap to keep debris from getting into the piping of the FDC and to prevent thread damage. The Siamese connection is universally used as a source of supply for sprinkler and standpipe systems. One significant advantage of this type of FDC is, if one hose fails, the operations' second line can continue to support the system while hose is changed out, unlike the use of a Storz connection utilizing a large-diameter hose.

Rowett (2017) listed some disadvantages of a Siamese connection: Caps become damaged and consistently come up missing, allowing the potential for debris to get into the piping of the FDC or become encrusted in the piping, due to lack of maintenance. The female swivel can become frozen, requiring an additional double male adapter to be threaded onto the FDC before connecting the hose. Missing FDC caps has been an ongoing battle for FFD. As of June of 2018, the department has been testing the Knox Secure Cap Program on a trial basis to try and resolve this issue.

The author determined that one specific type of FDC cannot support every fire protection system properly. A building with a sprinkler system itself can be supported sufficiently with a Storz connection and large-diameter hose and is an acceptable type of FDC. This is considered an ideal connection for FFD due to department size, operations, ease of use, and a universal connection that all mutual aid companies carry. The FFD does need to consider if the building is equipped with a standpipe system, the system's demand; if it is greater than 750 gpm, and if the structure is considered a high-rise. Research showed that these types of fire protection systems are better served with a Siamese connection due to pressure requirements. The Siamese

connection also provides a safety factor that a Storz connection cannot achieve and that is, if the large diameter hose breaks, the whole operation needs to be shut down until the hose is replaced. The author also understands that both the Storz and Siamese connections have pros and cons that need to be considered.

To date, FFD only submits a basic approval letter to the local building department approving or rejecting the plans. As research reported, the departments interviewed outside of the MABAS report submitting a plan review letter and an engineer print to the building department and contractor. The author believes that this creates consistency in regard to FDCs in other cities. Most departments outside of FFD MABAS reported that a Storz connection is being used on new fire protection systems but no report if they are considering the system demand requirements and the potential safety factor a Siamese connection has, especially, on standpipe systems.

Finally, the operational impact this standardization would have on the department is minimal. FFD needs to review current SOPs needs reviewed, evaluate current pre-plans (Rowett, 2017) and assess of current equipment on the trucks. The research also documented that a local assessment should also be conducted of area departments within the MABAS to verify all necessary equipment is available.

RECOMMENDATIONS

Over the past 35 years, the FFD has been proactive in identifying and preventing potential problems regarding fire protection systems. This approach should continue, but with additional emphasis on FDCs during the plan review process for future commercial construction.

After researching and reviewing the information, the author has identified several recommendations for FFD, as follows:

1. Follow the industry standard, NFPA 13 and NFPA 14, when conducting research on FDCs and fire protection systems. This allows the FFD to acquire the correct information for the type of FDCs required and what is permitted by the authority having jurisdiction. The O.F.C. also stipulates NFPA should be referenced for FDCs for fire protection systems.
2. Determine what type of FDC to utilize for suppression operations. NFPA and O.F.C. allow fire departments to determine the type of FDC within their jurisdiction. This should be accomplished by reviewing department operational guidelines and jurisdictional responses of other departments.
3. Design an engineer print for FDCs that includes five-inch Storz connection, height, and location within 40 feet of a hydrant to reinforce city ordinances (Appendix 6). This document will be utilized during the plan review process to specify the FDC requirements for the FFD.
4. Recommend FFD to utilize a five-inch Storz connection (with a 30-degree angle downturn) for all FDCs required on all new fire protection systems with a sprinkler system, and a Siamese connection for buildings with standpipes. For future buildings that are considered a high-rise (higher than 75 feet), a Siamese connection should be strongly considered due to the system demand requirements and the operational pressure that may be required to support these systems.

5. Specify that all five-inch Storz connections will be metal-faced without gaskets, made to the specified dimensions of NFPA 1963 (Appendix 1); and the dimensional characteristics of NFPA 1963 (Appendix 2).
6. Verify that all five-inch Storz connections have locking mechanisms to ensure against unintentional disconnection. Locks should be designed to be disengaged by hand in a separate action and capable of being unlocked by a firefighter wearing gloves, meeting the requirements of NFPA 1971 (NFPA 1963, 2019, p. 15). Verify that the FDC bears the markings as being tested by a third party.
7. Review current standard operating guidelines and update with revisions so the Storz connection can be put into service; first on current FDC combination setups (Storz and Siamese connection). This change in procedure should only be used on buildings equipped with sprinkler systems.
8. Update FFD pre-plans to include current type of FDC on existing buildings and re-evaluate equipment on all trucks utilized for this type of operation to determine that all required connections and adapters conform to all FDCs throughout the city.

An FDC is often a piece of the fire protection system that is underutilized, yet is required on almost all sprinkler and standpipe systems. The purpose of this research is to determine a standard for FDCs within the FFD for current and future fire protection systems. The author believes that this research project could become a valuable regionalization project between all local fire departments operating within Fairlawn's MABAS. With regionalization of FDCs, we can achieve cost savings measures, equipment consistency, and uniform fire suppression system procedures and operations.

REFERENCES

- Advameg, Inc. (2000/2016). *Work and Jobs in Fairlawn, Ohio (OH) Detailed Stats*. Retrieved January 2017, from City-Data.com: www.city-data.com/work/work-Fairlawn-Ohio.html
- American Legal Publishing. (2018, November 5). City of Fairlawn, Ohio Code of Ordinances. Retrieved from American Legal Publishing Company:
http://www.amlegal.com/codes/client/fairlawn_oh/
- Avsec, R. (2017, May 22). *Battalion Chief*. Retrieved July 25, 2017, from Fire Rescue 1:
<http://www.firerescue1.com/firefighter-training/article/249974018-The-fire-department>
- BSD SpecLink. (2014). *BSD SpecLink Supporting Documents*. Retrieved March 2018, from Section 21 1100 - Fire Suppression Water Service Piping: www.bssoftlink.com
- FM Global Group. (2016, November). *Approved Standard for Fire Department Connections*. FM. Retrieved 2017, from FM Approvals: <https://www.fmapprovals.com/products-we-certify/other-fire-protection-products>
- IFSTA. (2013). *Essentials of Fire Fighting and Fire Department Operations* (6th Edition ed.). (L. Murname, Ed.) Stillwater, Oklahoma: Brady Publishing.
- Klaene, B. ". (2016). *Structural Firefighting Strategy and Tactics*. Retrieved 2017, from Google Scholar: <https://books.google.com/books>
- NFPA 1 Fire Code. (2018). *Fire Code*. Retrieved 2018, from National Fire Codes Subscription Services: <http://codesonline.nfpa.org>
- NFPA 13. (2016). *Standard for the Installation of Sprinkler Systems*. Retrieved from National Fire Codes, Subscription Service: <http://codesonline.nfpa.org>
- NFPA 13. (2016). *Standard for the Installation of Sprinkler Systems*. Retrieved from National Fire Codes, Subscription Service: <http://codesonline.nfpa.org>

- NFPA 14. (2016). *Standard for the Installation of Standpipe and Hose Systems*. Retrieved 2017, from National Fire Codes, Subscription Service: <https://codesonline.nfpa.org>
- NFPA 14. (2016). *Standard for the Installation of Standpipe and Hose Systems*. Retrieved from National Fire Codes, Subscription Service: <https://codesonline.nfpa.org>
- NFPA 14. (2016). *Standard for the Installation of Standpipe and Hose Systems*. Retrieved from National Fire Codes, Subscription Service: <http://codesonline.nfpa.org>
- NFPA 1963. (2014). *Standard for Fire Hose Connections*. Retrieved from National Fire Codes, Subscription Service: <http://codesonline.nfpa.org>
- NFPA 1963. (2019). *Standard for Fire Hose Connections*. Retrieved 2019, from National Fire Codes Subscription Service: <http://www.codesonline.nfpa.org>
- NFPA. (2018). *About NFPA*. Retrieved from [nfpa.org](http://www.nfpa.org): <http://www.nfpa.org>
- NFPA 24. (2016). *Standard for the Installation of Private Fire Service Mains and Their Appurtenances*. Retrieved from National Fire Codes, Subscription Service: <https://codesonline.nfpa.org>
- NFPA Research Foundation. (2016). *Fire Department Connection Inlet Flow Assessment*. Exponent, Inc. Retrieved from NFPA: <https://www.nfpa.org/News-and-Research/Fire-statistics-and-reports/Research-reports/Suppression/Fire-Department-Connection-Inlet-Flow-Assessment>
- Ohio Fire Code. (2011). *Fire Department Connections*. Falls Church: International Code Council.
- Rowett, A. J. (2017, July 11). *Understanding the Use of Fire Department Connections*. Retrieved from Firehouse: www.firehouse.com/understanding-the-use-of-fire-department-connections-firefighter-training
- Shapiro, J. (1997). *Fire Protection Handbook* (18th Edition ed.). Quincy, MA: NFPA.

U.S.Fire Administration. (2014-2018). America's Fire and Emergency Services Leader.

APPENDIX 1 – NFPA, FDC STORZ REQUIRED DIMENSIONS

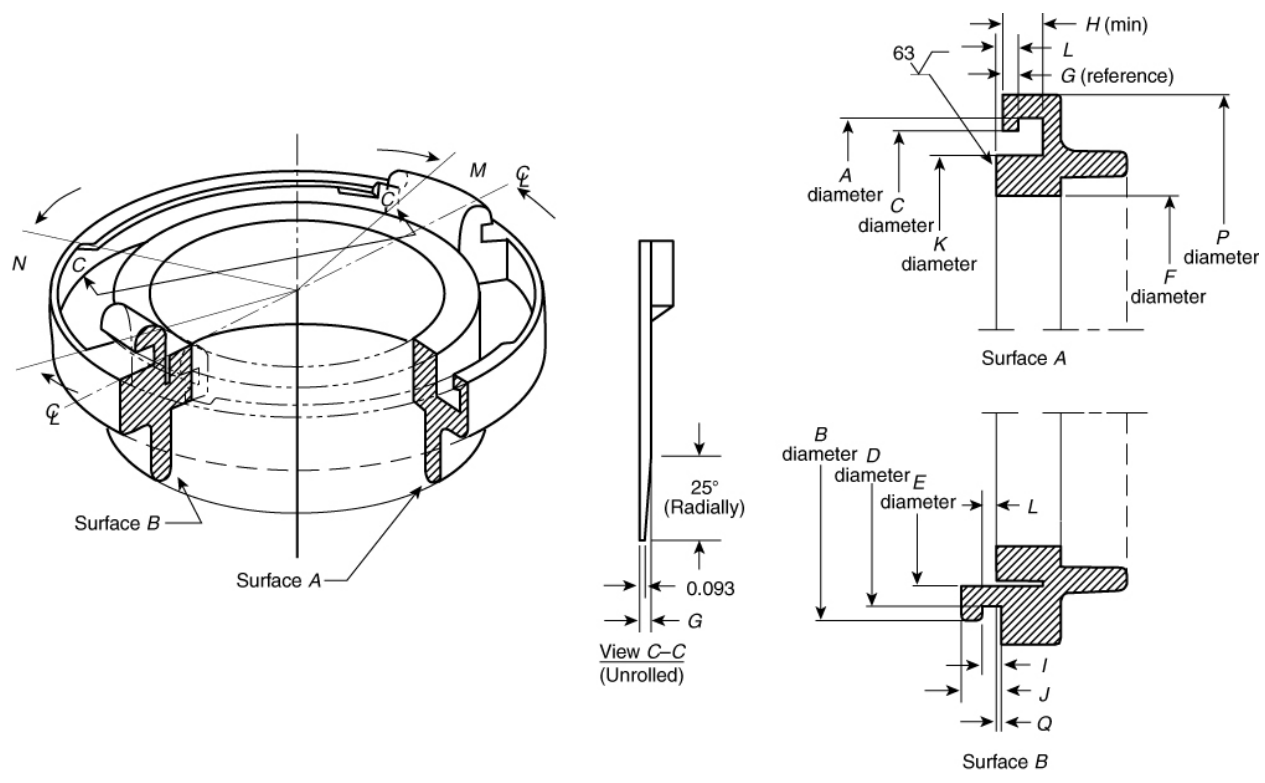

Size	A	B	C	D	E	F	G	H	I	J	K	L	M	N	P	Q
4 in.	5.500	5.472	5.197	5.118	4.528	3.500	0.190	0.576	0.236	0.532	4.500	0.213 ± .002	15°	35°	6.142	0.023 ± .002
5 in.	6.957	6.929	6.575	6.496	5.826	4.500	0.220	0.653	0.295	0.622	5.750	0.258 ± .002	16°	36°	7.717	0.038 ± .002

Note 1: All linear measurements in inches. Tolerances: .XXX = ± .005 in. unless otherwise noted; angles ± ½ degree
 Note 2: Attachment to hydrant or piping to fire department connection — as specified by purchaser.
 Note 3: All dimensions are to be the same for similar configurations on the hydrant or fire department connection.

APPENDIX 2 – 6.2.2(a) END VIEW OF 4-INCH METAL FACE STORZ CONNECTION

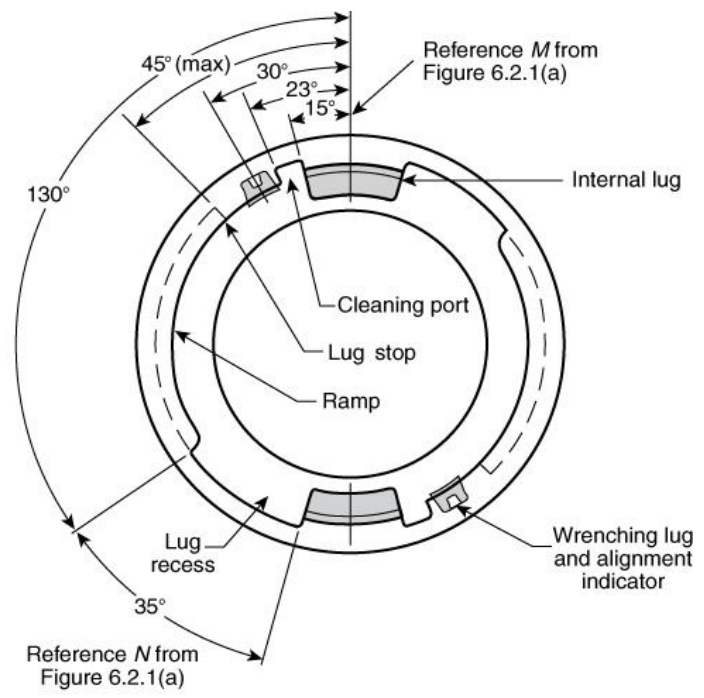

Note: All dimensions are to be the same for similar configurations on the gauge.

APPENDIX 3 – 6.2.2 (b) END VIEW OF 5-INCH METAL FACE STORZ CONNECTION

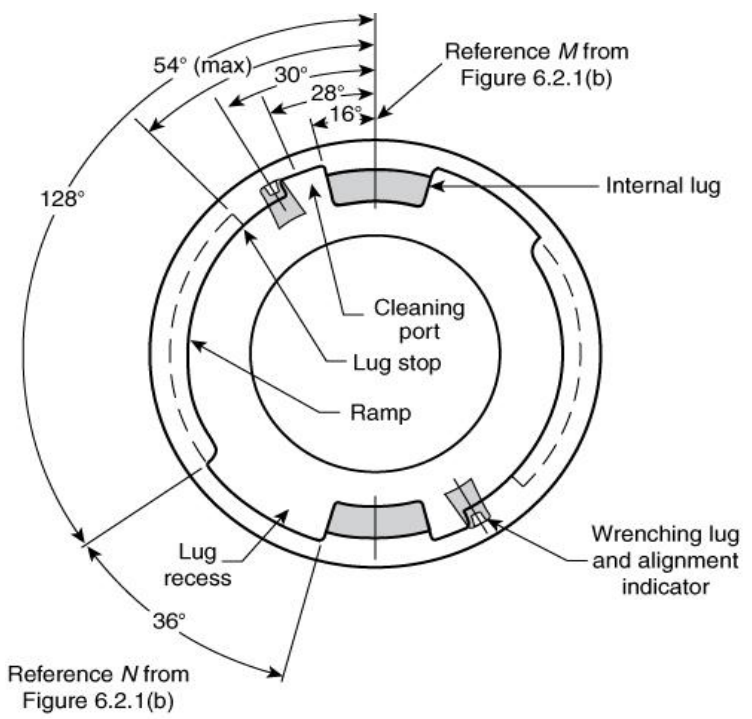

Note: All dimensions are to be the same for similar configurations on the gauge.

APPENDIX 4 – INTERNAL SURVEY

July 3, 2018

Dear Fire Service Colleague,

As a student of the Ohio Fire Executive Program, I am required to complete an Applied Research Project. I am currently researching fire department connection standards for fire protection systems. The purpose of this research is to identify a standardization for fire department connections in the City of Fairlawn.

Your help is needed to complete a quick survey below that will assist with this research project.

The survey is anonymous, and no department identifiers will be used in my research project from this survey. Please complete survey by Monday, July 23, 2018. To access survey just click on the following web link:

<https://www.surveymonkey.com/r/BX9QK9K>

Thank you for your time and your support of this project. For any further questions or assistance, I can be reached at (330) 618-9056 or by email: lesherd@fairlawn.us .

Respectfully,

Lt. David Lesher
Fairlawn Fire Department
3525 S. Smith Road
Fairlawn, Ohio 44333
330-668-9540

Q1 How useful is the FDC for suppression operations in commercial structures?

Answered: 12 Skipped: 0

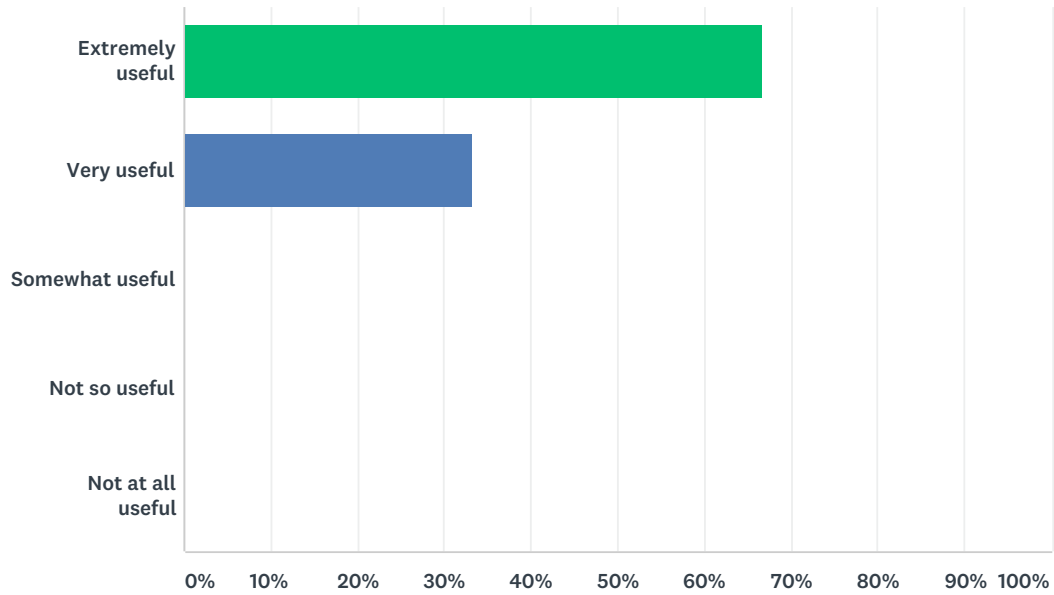

ANSWER CHOICES	RESPONSES	
Extremely useful	66.67%	8
Very useful	33.33%	4
Somewhat useful	0.00%	0
Not so useful	0.00%	0
Not at all useful	0.00%	0
TOTAL		12

Q2 Would a standardization for FDCs be beneficial for Fairlawn Fire Department?

Answered: 12 Skipped: 0

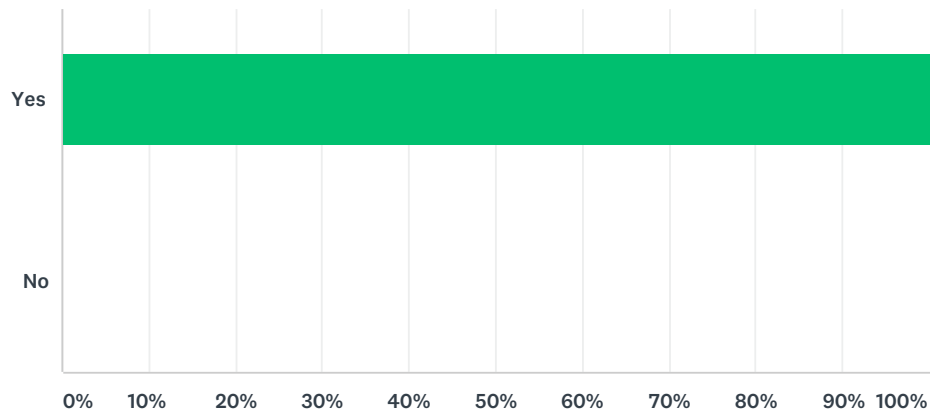

ANSWER CHOICES	RESPONSES	
Yes	100.00%	12
No	0.00%	0
TOTAL		12

Q3 If a standard for FDCs was implemented, what type should be utilized?

Answered: 12 Skipped: 0

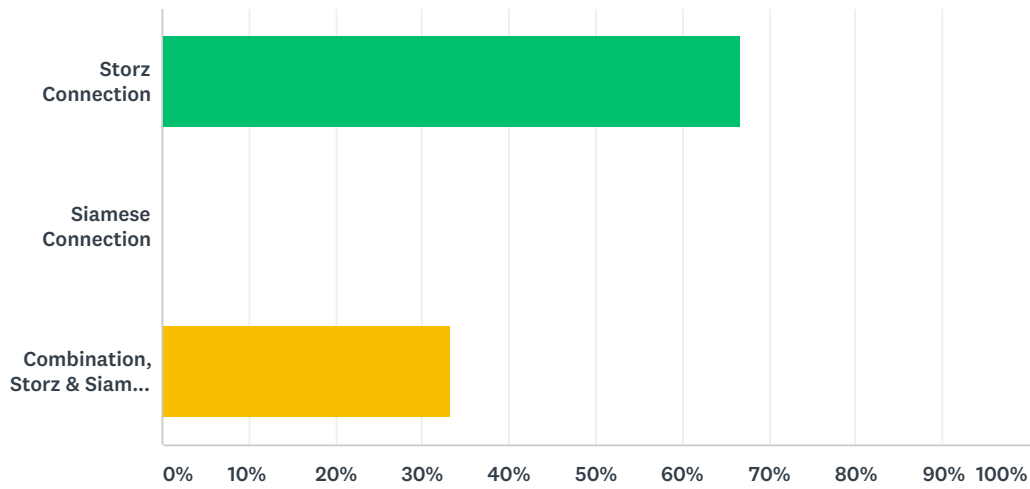

ANSWER CHOICES	RESPONSES	
Storz Connection	66.67%	8
Siamese Connection	0.00%	0
Combination, Storz & Siamese Connection	33.33%	4
TOTAL		12

Q4 If a Storz connection was implemented what size should be used?

Answered: 12 Skipped: 0

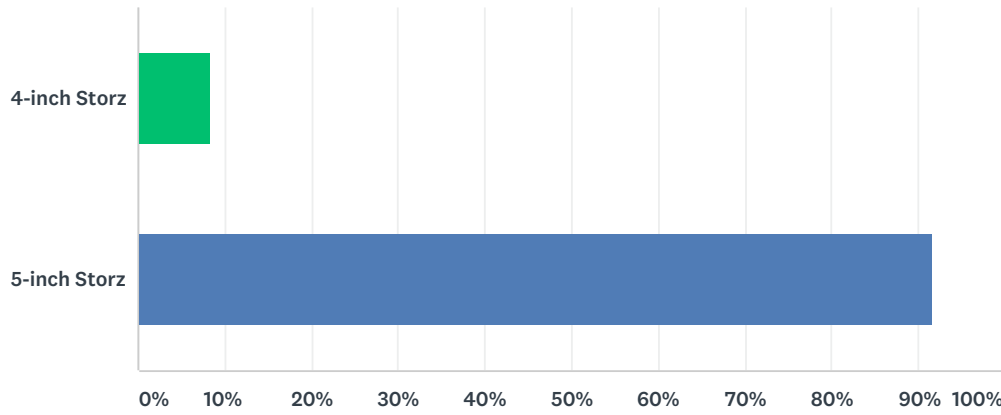

ANSWER CHOICES	RESPONSES	
4-inch Storz	8.33%	1
5-inch Storz	91.67%	11
TOTAL		12

Q5 Should 3-inch or 2.5-inch hose be used on a Siamese connection due to friction loss?

Answered: 12 Skipped: 0

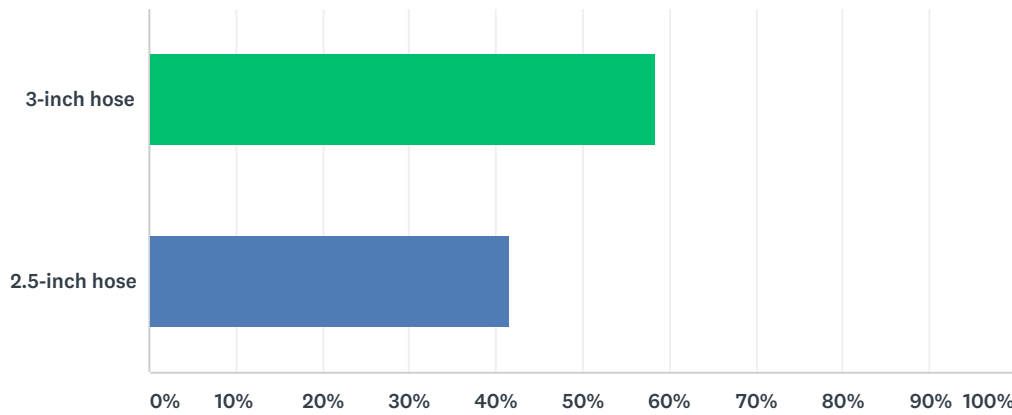

ANSWER CHOICES	RESPONSES
3-inch hose	58.33% 7
2.5-inch hose	41.67% 5
TOTAL	12

Q6 How familiar are you with the operation of a FDC if needed for suppression operations?

Answered: 12 Skipped: 0

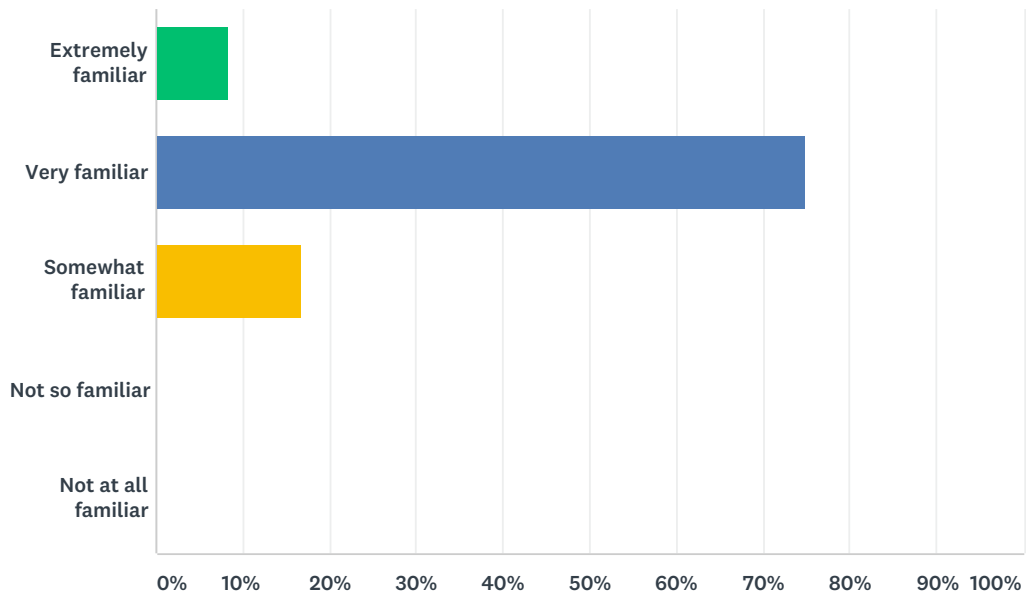

ANSWER CHOICES	RESPONSES
Extremely familiar	8.33% 1
Very familiar	75.00% 9
Somewhat familiar	16.67% 2
Not so familiar	0.00% 0
Not at all familiar	0.00% 0
TOTAL	12

Q7 Do you feel the department has provided you with enough training and information on FDC's for adequate suppression operations?

Answered: 12 Skipped: 0

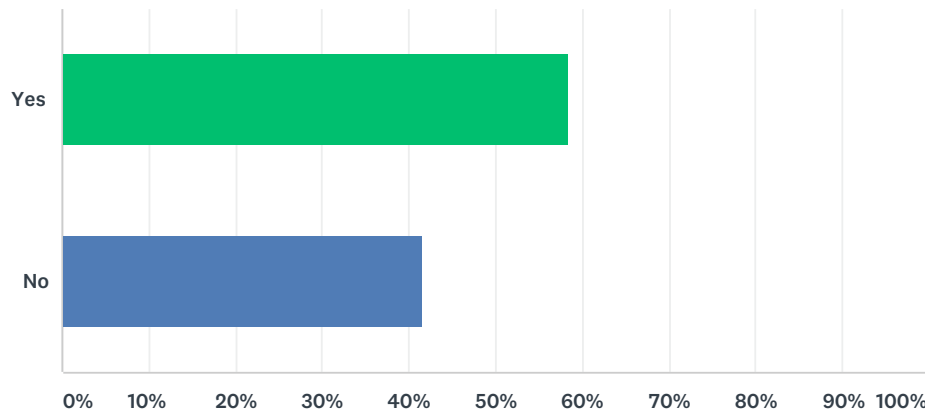

ANSWER CHOICES	RESPONSES	
Yes	58.33%	7
No	41.67%	5
TOTAL		12

APPENDIX 5 – EXTERNAL SURVEY

July 2, 2018

Dear Fire Service Colleague,

As a student of the Ohio Fire Executive Program, I am required to complete an Applied Research Project. I am currently researching fire department connection standards for fire protection systems. The purpose of this research is to identify a standardization for fire department connections in the City of Fairlawn.

Your help in completing the survey will assist in answering the following research questions: a.) What is code and what standard should we be following? b.) How have other departments standardized their fire department connections and what rule have they adopted? c.) What type of fire department connection is best suited for suppression operations, what are the advantages and disadvantages of each connection? d.) What kind of operational impact for the department would this standardization create?

Your input is important and will be used in my project. The survey is anonymous, and no department identifiers will be used in my research project from this survey. If you have a current department standard or engineer prints for fire department connection, please email to lesherd@fairlawn.us. Please complete survey by Monday, July 16, 2018. To access survey just click on the following web link:

<https://www.surveymonkey.com/r/WN5JV9J>

Thank you for your time and your support of this project. For any further questions or assistance, I can be reached at (330) 618-9056 or by email: lesherd@fairlawn.us.

Respectfully,

Lt. David Lesher
Fairlawn Fire Department
3525 S. Smith Road
Fairlawn, Ohio 44333
330-668-9540

Q1 Does your department reference NFPA standard on their local Fire Protection Systems and FDCs?

Answered: 16 Skipped: 0

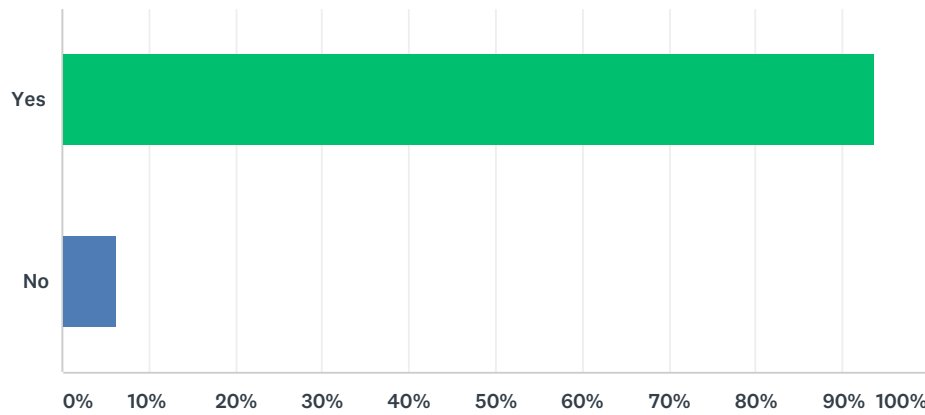

ANSWER CHOICES	RESPONSES	
Yes	93.75%	15
No	6.25%	1
TOTAL		16

Q2 Does your department have a standardization for FDCs within your jurisdiction?

Answered: 16 Skipped: 0

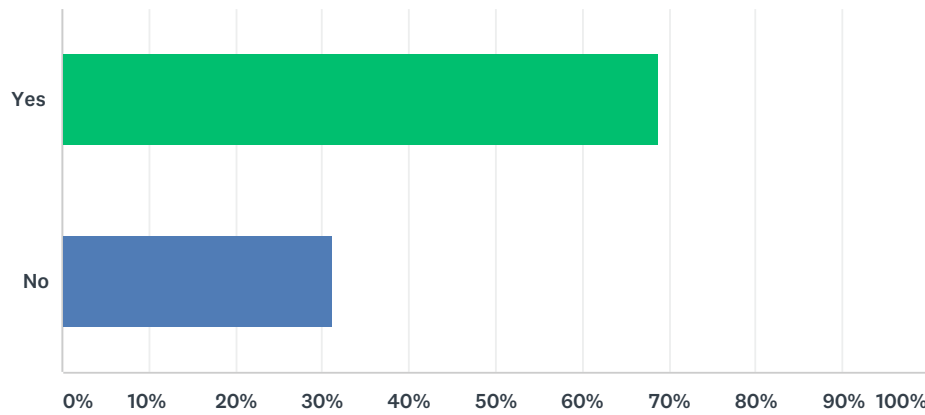

ANSWER CHOICES	RESPONSES	
Yes	68.75%	11
No	31.25%	5
TOTAL		16

Q3 Who determines within your jurisdiction what type of FDC will be utilized for fire protection.

Answered: 16 Skipped: 0

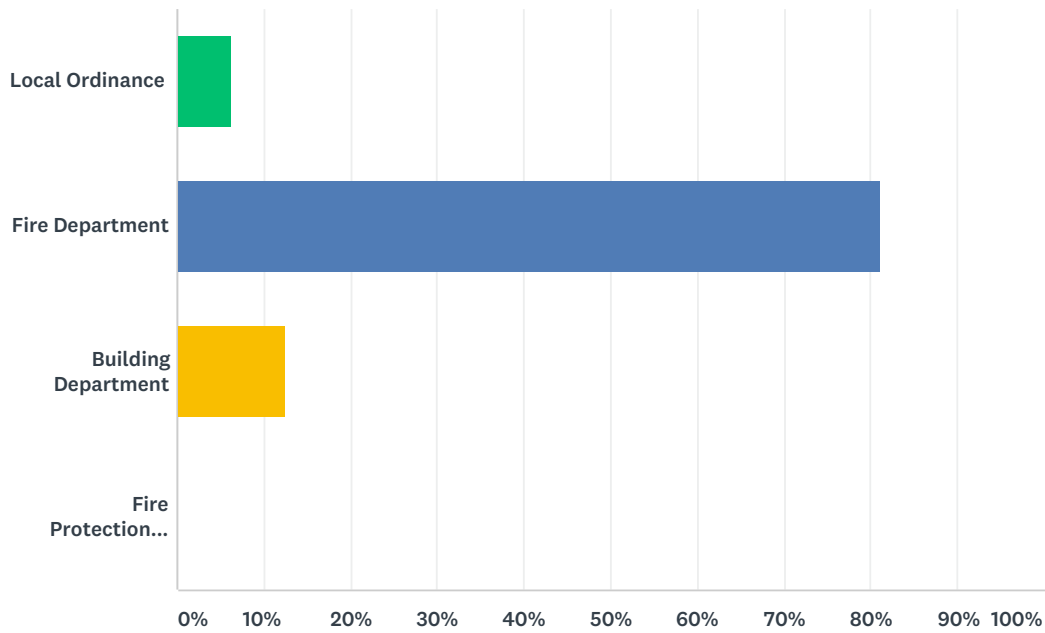

ANSWER CHOICES	RESPONSES	
Local Ordinance	6.25%	1
Fire Department	81.25%	13
Building Department	12.50%	2
Fire Protection Designer	0.00%	0
TOTAL		16

Q4 What type of FDC is required in your jurisdiction on new commercial buildings when required?

Answered: 16 Skipped: 0

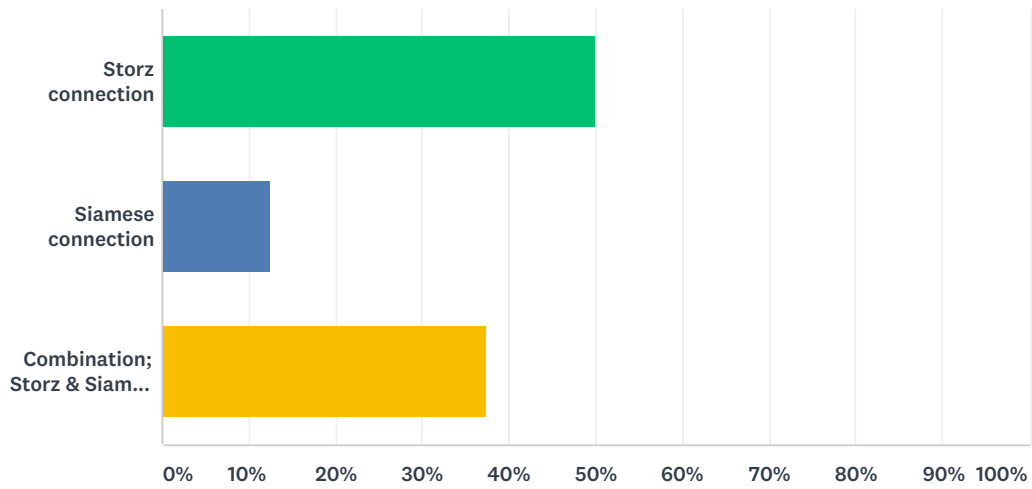

ANSWER CHOICES	RESPONSES
Storz connection	50.00% 8
Siamese connection	12.50% 2
Combination; Storz & Siamese connection	37.50% 6
TOTAL	16

Q5 What operational advantages/disadvantages were identified in the departments FDC selection in question two, please explain?

Answered: 15 Skipped: 1

#	RESPONSES	DATE
1	Standardization mad it much easier for all responding units to get better flows when needed and to eliminate the questions of non-standardization when arriving on scene	7/12/2018 1:58 PM
2	easy connection with current hose	7/11/2018 11:17 AM
3	Quick attachments for front line personnel	7/11/2018 8:07 AM
4	Continuity with siamese	7/10/2018 5:33 PM
5	Change in Chiefs brings a change in what's viewed as best (Storz vs Siamese)	7/10/2018 3:59 PM
6	No retro in place requiring them to change to storz, only new construction.	7/10/2018 3:18 PM
7	N/A	7/10/2018 12:00 PM
8	4inch single supply	7/10/2018 11:55 AM
9	Ease of use	7/9/2018 10:18 PM
10	Combination because you have a backup if needed.	7/9/2018 10:15 PM
11	Siamese needing maintenance due to caps freezing and having to use adapters. Storz connection quicker to use with limited manpower.	7/3/2018 7:09 AM
12	If storz connection fails, Siamese as a backup	7/3/2018 7:00 AM
13	Ease of use	7/2/2018 4:18 PM
14	I don't know	7/2/2018 4:18 PM
15	STORZ has an ease of use and our trucks care plenty of LDH no additional fittings needed.	7/2/2018 3:12 PM

Q6 If your jurisdiction utilizes a Storz connection for a FDC, what size is this connection?

Answered: 16 Skipped: 0

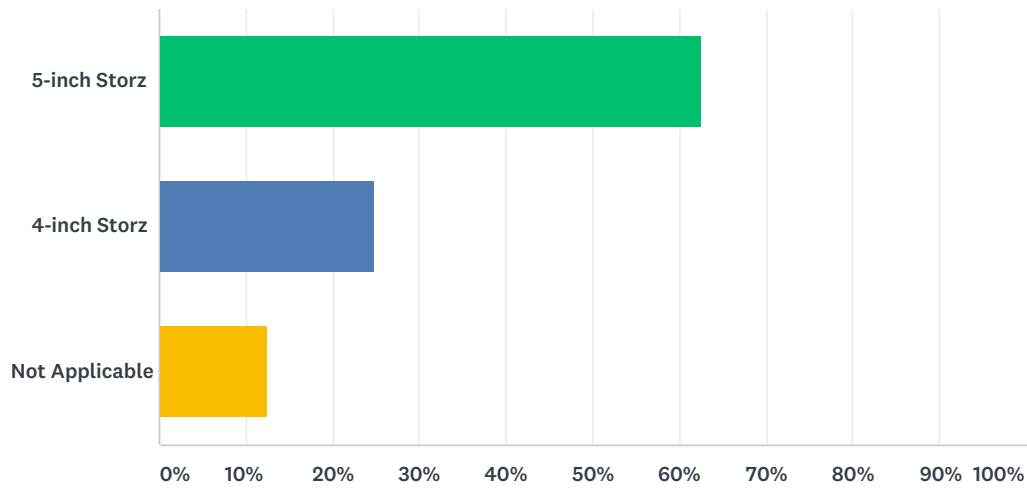

ANSWER CHOICES	RESPONSES	
5-inch Storz	62.50%	10
4-inch Storz	25.00%	4
Not Applicable	12.50%	2
TOTAL		16

Q7 When selecting an FDC, how important is it to have the markings of a third-party testing facility, e.g. Factory Mutual (FM), Underwriters Laboratory (U.L)?

Answered: 16 Skipped: 0

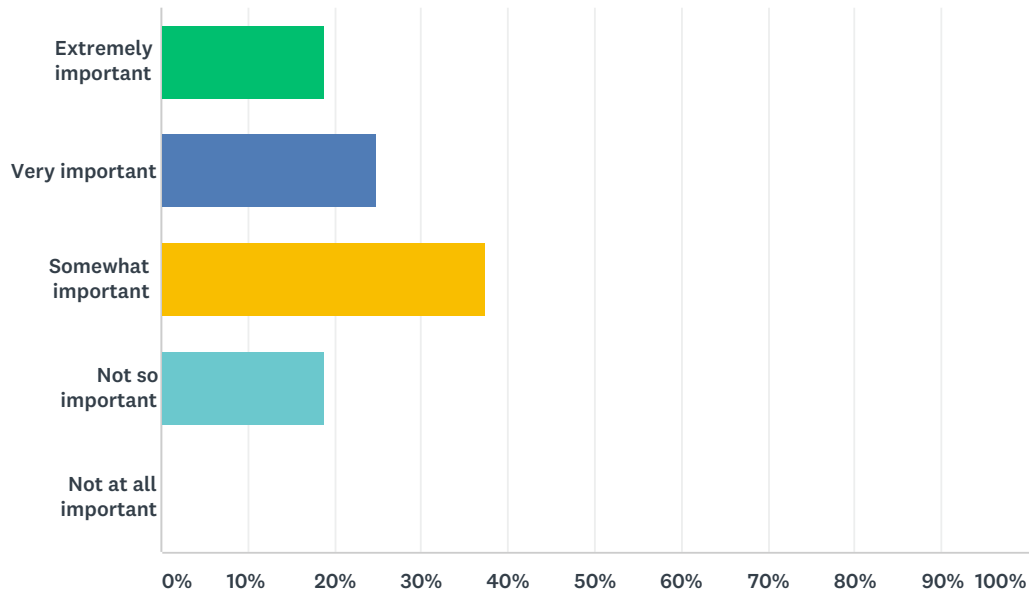

ANSWER CHOICES	RESPONSES	
Extremely important	18.75%	3
Very important	25.00%	4
Somewhat important	37.50%	6
Not so important	18.75%	3
Not at all important	0.00%	0
TOTAL		16

Q8 Approximately, how many times in the past 10 years was an FDC placed in service for suppression operations within your community?

Answered: 16 Skipped: 0

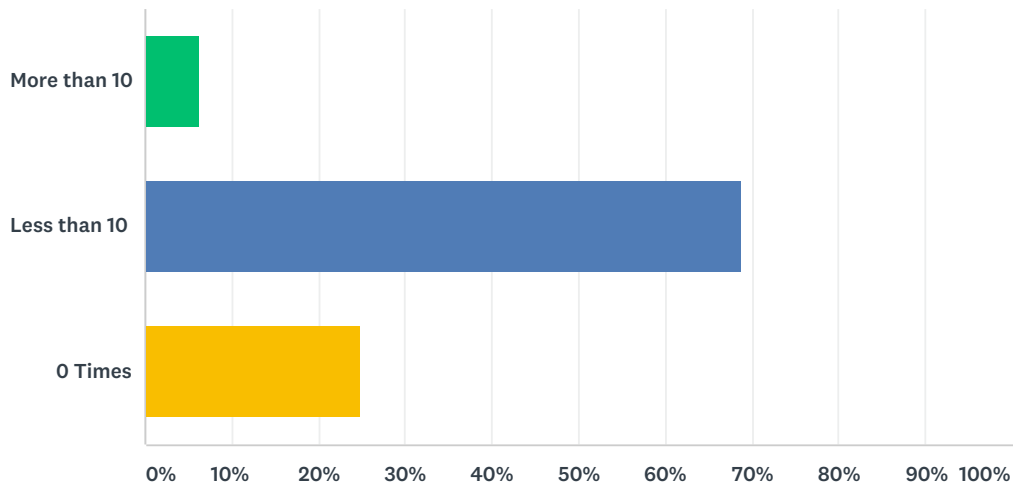

ANSWER CHOICES	RESPONSES	
More than 10	6.25%	1
Less than 10	68.75%	11
0 Times	25.00%	4
TOTAL		16

Q9 Does your city/village/township have buildings where the floor of an occupiable story is greater than 75ft (High Rise).

Answered: 16 Skipped: 0

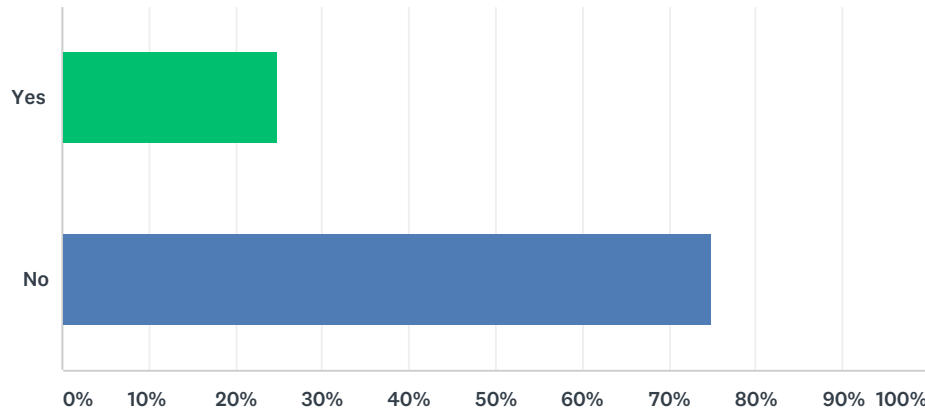

ANSWER CHOICES	RESPONSES	
Yes	25.00%	4
No	75.00%	12
TOTAL		16

#	IF YOU ANSWERED YES, PLEASE LIST THE TYPE OF FDC, STORZ CONNECTION, SIAMESE CONNECTION OR COMBINATION-STORZ & SIAMESE.	DATE
1	Siamese	7/13/2018 6:13 PM
2	Storz and siamese connections	7/11/2018 11:17 AM
3	Hamilton has multiple high rise buildings some of them have 4 inch storz connections and some have 2.5 inch siamese connections	7/11/2018 8:07 AM
4	Siamese	7/3/2018 7:09 AM

APPENDIX 6 – FDC - ENGINEER PRINT

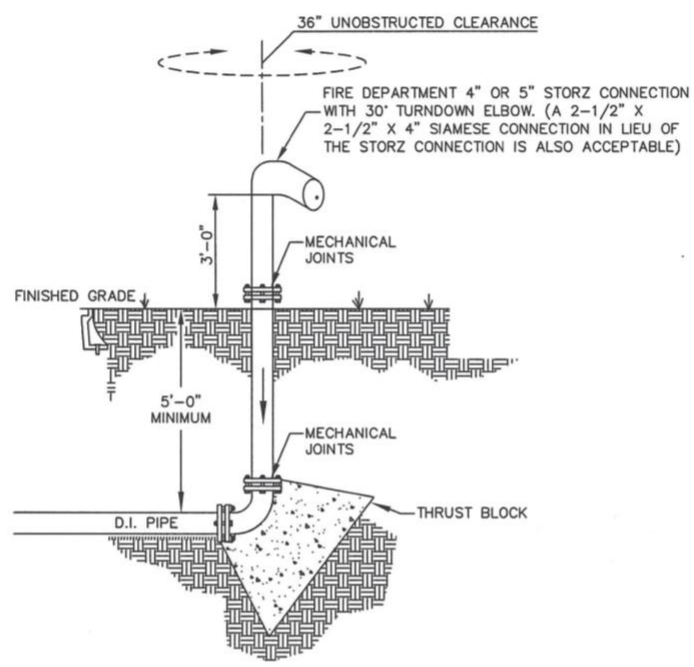

- NOTES:**
- 1) REMOTE FIRE DEPARTMENT CONNECTION (FDC) SHALL BE LOCATED REMOTELY FROM THE STRUCTURE AND OUT OF THE COLLAPSE ZONE.
 - 2) REMOTE FDC SHALL BE LOCATED WITHIN 40 FEET OF A FIRE HYDRANT, ON THE SAME SIDE OF THE STREET, PER CITY ORDINANCE.
 - 3) FDC'S SHALL BE A FIVE INCH (5") STORZ CONNECTION WITH THIRTY DEGREE (30°) ELBOW.
 - 4) A SIGN SHALL BE PERMANENTLY AFFIXED TO THE FDC STATING THE ADDRESS IT SERVES.
 - 5) PIPE SIZE SHALL BE DETERMINED BY HYDRAULIC CALCULATIONS, BUT SHALL BE A MINIMUM OF FOUR INCH (4") DIAMETER.

F:\BLOCKS\FAIRLAWN STANDARDS\FDC

CITY OF FAIRLAWN	
REMOTE FIRE DEPARTMENT CONNECTION	
DATE: 12-14-18	